



NOVA P300c

**Product Manual**

English

# Foreword

**Thank you for purchasing Aputure® NOVA P300c.  
The Aputure NOVA P300c is a color panel lamp with wide color gamut.**

## IMPORTANT SAFETY INSTRUCTIONS

Basic safety precautions should always be followed while using the unit, as following:

1. Please read and understand these instructions before using it.
2. Close supervision is necessary when the fixture is used or near to children, Please don't put it unattended while normally operating
3. Care must be taken of burning could occur from touching hot surface.
4. Don't operate the fixture if a cord is damaged or the fixture has been dropped or damaged - until it has been examined by qualified service personnel.
5. Position any power cables such that they will not be tripped over, pulled, and don't touch them with hot surfaces.
6. If an extension cord is necessary, a cord with an amperage rating at least equal to that of the fixture should be used. Cords rated for less amperage than the fixture may overheat.
7. Always unplug the lighting fixture from the electrical outlet before cleaning and servicing, or when not in use. Never yank the cord to remove the plug from the outlet.

8. Let the lighting fixture cool completely before storing.
9. To reduce the risk of electric shock, don't immerse this fixture in water or any other liquid.
10. To reduce the risk of electric shock, don't disassemble this fixture. Contact Aputure Customer Service or take it to qualified service personnel when service or repair work is required. Incorrect reassembly may cause electric shock when the lighting fixture is in use.
11. Use an accessory attachment not recommended by the manufacturer may increase the risk of fire, electric shock, or injury to any person operating the fixture.
12. Power this fixture by connecting it to a grounded outlet.
13. Please don't place the LED lighting fixture near any liquid or other flammable object.
14. Only use a dry microfiber cloth to clean the product.
15. Please don't operate the fixture in damp environment or exist risk of short circuit or electrical shock
16. Please contact authorized service personnel while repair is necessary . The malfunctions caused by unauthorized disassemble are not covered under the warranty but pay for maintenance.
17. We recommend only using the original Aputure cable accessory. Please note that our warranty for this product does not apply to any repair required due to any malfunctions of unauthorized Aputure accessories, although you may request such repairs for a fee.
18. This product is certified by RoHS, CE, KC, PSE, and FCC.  
Please operate the product in full compliance with the operation standards. Please note that this warranty does not apply to repairs arising from malfunctions, although you may request such repairs on a chargeable basis.

19. The instructions and information in this manual are based on thorough, controlled company testing procedures. Further notice will not be given if the design or specifications change.

# SAVE THESE INSTRUCTIONS

## FCC Compliance Statement

This device complies with Part 15 of the FCC Rules. Operation is subject to the following two conditions:

- (1) This device may not cause harmful interference.
- (2) This device must accept any interference received, including interference that may cause undesired operation.

**Warning:** Changes or modifications not expressly approved by the party responsible for compliance could void the user's authority to operate the equipment.

**NOTE:** This equipment has been tested and found to comply with the limits for a Class B digital device, pursuant to Part 15 of the FCC Rules. These limits are designed to provide reasonable protection against harmful interference in a residential installation. This equipment generates, uses, and can radiate radio frequency energy and, if not installed and used in accordance with the instructions, may cause harmful interference to radio communications. However, there is no guarantee that interference will not occur in a particular installation. If this equipment does cause harmful interference to radio or television reception, which can be determined by turning the equipment off and on, the user is encouraged to try reorient or relocate the receiving antenna.

- Increase the separation between the equipment and receiver.
- Connect the equipment into an outlet on a circuit different from that to which the receiver is connected.
- Consult the dealer or an experienced radio/TV technician for help.

## RF Warning Statement:

This device has been evaluated to meet general RF exposure requirements.

## Components List

Please make sure all accessories listed below are completed before using. If not, please contact with your sellers immediately.

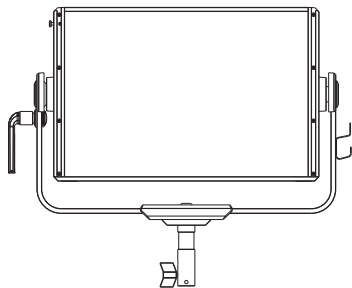

Nova P300c  
Lamp Head (1 pc)

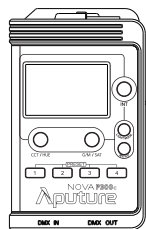

Paracord  
Strap(1 pc)

Control Box  
(1 pc)

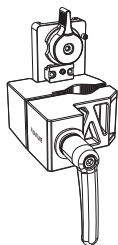

Lightning Clamp  
(1 pc)

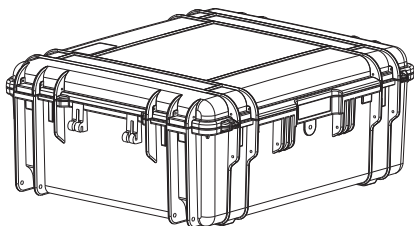

Nova P300c Custom Hard Shell  
(Available in Kit/Sold Separately) (1pc)

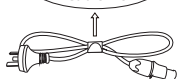

Neutrik® powerCON AC  
Power Cable (6m) (1 pc)

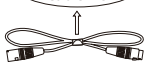

5-Pin Male-to-Female  
XLR Head Cable (3m) (1 pc)

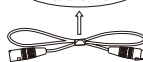

5-Pin Male-to-Female  
XLR Head Cable (0.6m) (1 pc)

# Product Details

## 1. Light

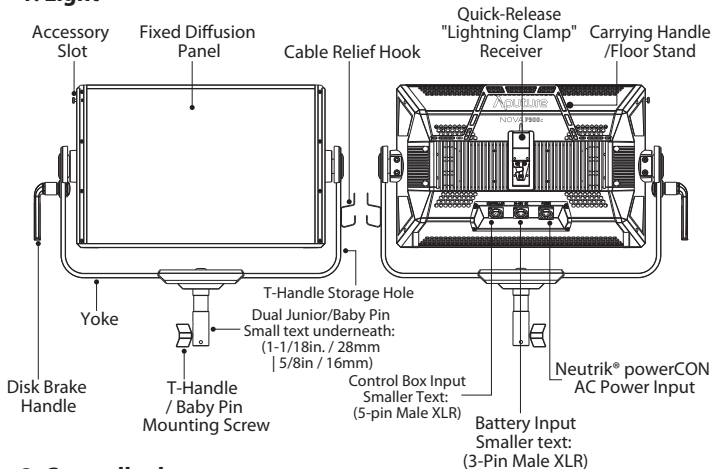

## 2. Controller box

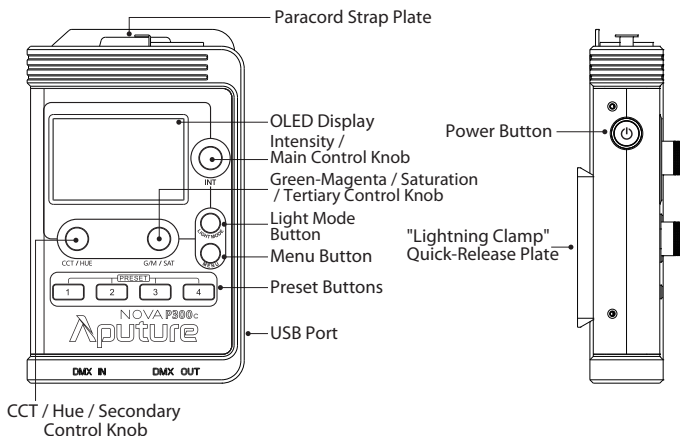

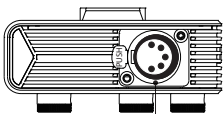

5-Pin Female XLR Control Box Input

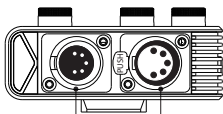

DMX IN Port DMX OUT Port

## Installations

### 1. Setting Up Your Light

Baby Pin (5/8in. / 16mm)

Mount the lamp head onto a light stand, then fix it in place by tightening the T-Handle on the mounting column. Then loosen/tighten the handbrake locking mechanism on the yoke to adjust the tilt of the fixture.

Junior Pin

Remove the T-Handle from the Junior Pin and screw it into the T-Handle Storage Hole on the yoke. Place the light into the Junior Pin Receiver on the stand, and tighten down the T-Handle on the receiver.

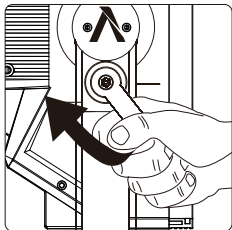
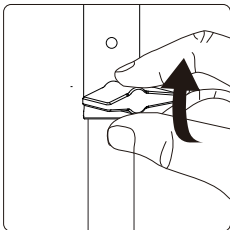

### 2. Connect the light to the control box

Connect the light to the control box with a 5-Pin Male-to-Female XLR cable (3m or 0.6m) as shown below.

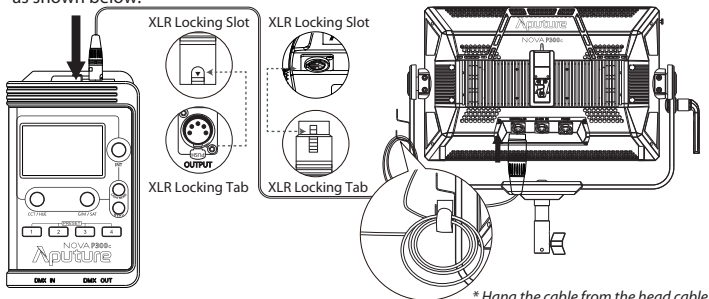

\*\* Disconnect the XLR head cable by pushing down on the locking tabs on the female XLR connectors, then remove the cable.

\*The lamp controller interface schematic is shown in the pictures below:

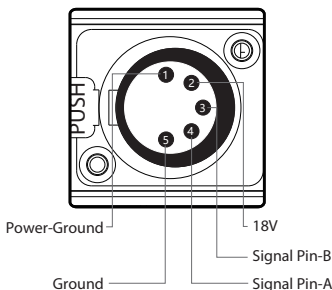

### 3. Instructions for the Lightning Clamp

- 1) Clamp the Lightning Clamp onto a light stand.
- 2) To attach the control box, rotate the release lever to unlock the quick-release baseplate, then mount the control box onto the Lightning Clamp (the release lever will automatically spring back).
- 3) To remove the control box, grasp it firmly, then unlock the quick-release plate by turning the release lever, and detach the control box.
- 4) For the Lightning Clamp Receiver on the back of the lamp head, the using method of fixing is similar with the Lightning Clamp.

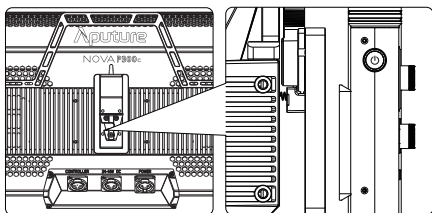
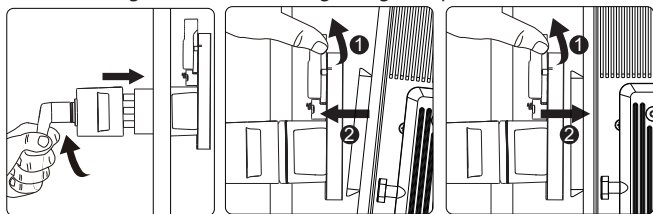



## Specifications

Weight	670g / 1.48lbs	Sizes (L*W*H)	10.35x8.74x12.5cm / 4.07x3.44x4.92in
* The Quick-Release "Lightning Clamp" can clamp onto square or round pipe with a diameter between 2-5cm or 0.79-1.97in.			

## 4. Powering up the Light

### 1) Powered by AC

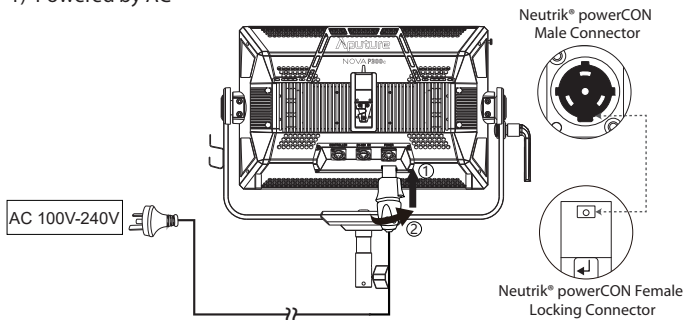

To disconnect the Neutrik® powerCON cable, pull back on the yellow release tab on the cable connector, and rotate the connector counterclockwise.

### 2) Powered by Battery

You can also power this light via DC 24V-48V Power from a 3-pin XLR. This can be done via our an Aputure Battery Power Station that supports 48V output, or other power stations or block batteries that are capable of outputting the same voltage.

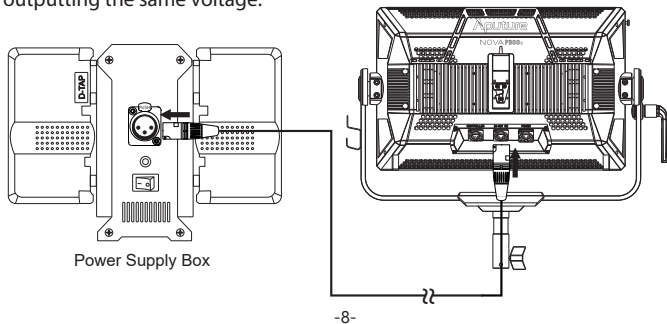

# Operation Instructions

## 1. Turning on the Light

After connecting the lamp head to an appropriate power source, connect the lamp head and control box with one of the included 5-Pin Male-to-Female XLR Head Cables. Press the power button on the side of the control box to turn the light on and off.

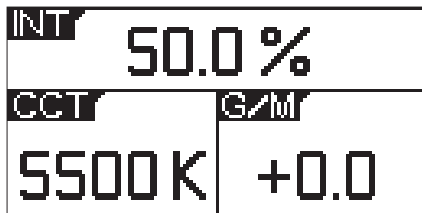
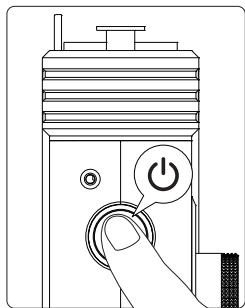

## 2. Manual Control

2.1. Rotate the Intensity (INT) Control Knob to adjust the intensity of the light from 0-100%.

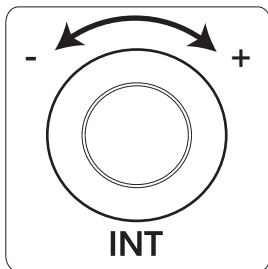

Rotate the CCT / HUE Control Knob to adjust the CCT or HUE Output of the light fixture.

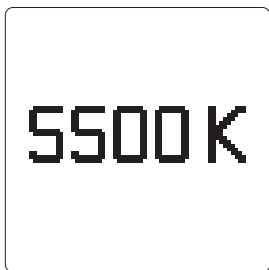
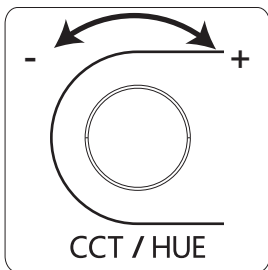

Rotate the Green-Magenta / Saturation (G/M / SAT) Control Knob to adjust the the Green-Magenta Shift or Saturation output of the light fixture.

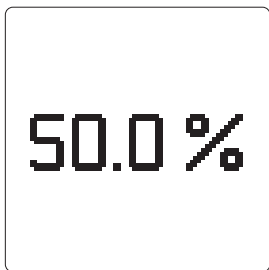
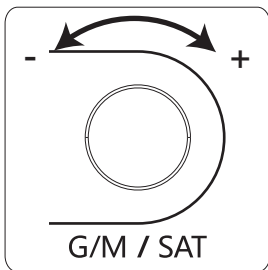

*\* The speed at which you rotate the knob will result in different rates of change.*

## 2.2. Light Mode Interface

Press the Light Mode button to enter the system.



2.2.1 Press the INT button to select CCT mode to adjust the color temperature of the light from 2000K-10000K.

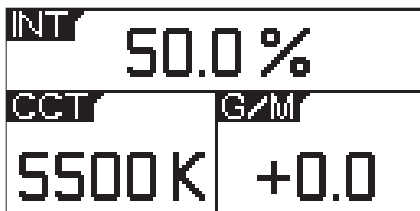

2.2.2 Press the INT button to select HSI mode to adjust the change of the HUE from 1°~360°.

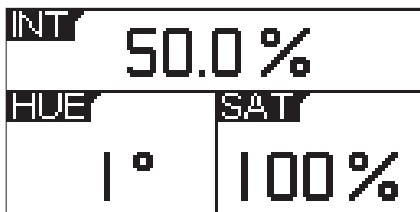

2.2.3 Press the INT button to select FX mode, then rotate the INT control knob to toggle between Club Lights, Paparazzi, Lightning, TV, Candle, Fire, Strobe, Explosion, Fault Bulb, Pulsing, Welding, Cop Car, Color Chase, Party Lights, Fireworks.

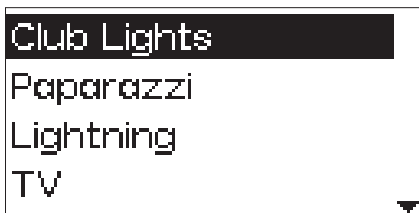

a. Club Lights

Club Lights	INT 50.0%
COLORS	SPD
3	05

b. Paparazzi

Paparazzi	INT 50.0%
CCT	FRQ
	05

c. Lightning

Lightning	INT 50.0%
CCT	FRQ
	05 >

d. TV

TV	INT 50.0%
Warmer Natural Cooler	SPD
	05

e. Candle

Candle	INT 50.0%
Warmer Natural Cooler	SPD
	05

f. Fire

Fire	INT 50.0%
Warmer Natural Cooler	SPD
	05

## g. Strobe

Strobe	INT 50.0%
SOURCE CCT HSI	SPD 05

## h. Explosion

Explosion	INT 50.0%
SOURCE CCT HSI	Decay 05

## i. Fault Bulb

Faulty Bulb	INT 50.0%
SOURCE CCT HSI	FRQ 05 >

## j. Pulsing

Pulsing	INT 50.0%
SOURCE CCT HSI	FRQ 05 >

## i. Welding

Welding	INT 50.0%
SOURCE CCT HSI	FRQ 05 >

## j. Cop Car

Cop Car	INT 50.0%
R+B+W R B	FRQ 05

## k. Color Chase

Color Chase	INT 50.0%
SAT 100%	SPD 05

## l. Party Lights

Party Lights	INT 50.0%
SAT 100%	SPD 05

## m. Fireworks

Fireworks	INT 50.0%
CCT+HUE CCT HUE	FRQ 05

Under anyone FX mode, press the INT control knob to circulate the light effect and press the INT control knob again to pause the light effect. But under Lightning and Explosion, press the INT control knob, it will become trigger.

2.2.4 Press the INT button to select RGB mode to adjust the brightness via change the scale of each of R/G/B.

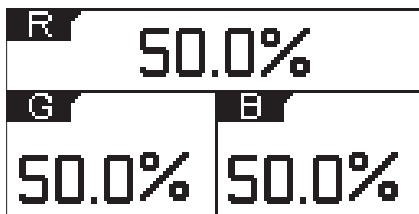

2.2.5 Press the INT button to select X, Y color coordinate mode, press or rotate the HUE control knob to change the figure of X and press the SAT control knob to change the figure of Y.

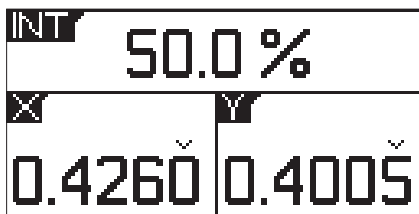

2.2.6 Press the INT button to select SOURCE mode, then rotate the INT control knob to select appropriate source.



2.2.7 Press the INT button to select GEL mode, then rotate the INT control knob to adjust the brightness, rotate the INT control knob to choose 3200K/5600K and press G/M control knob to enter the interface of GEL.



2.3 Press the MENU button to enter the system of menu interface, as shown below.

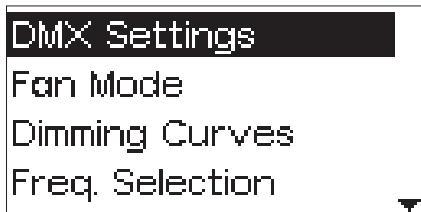

### 2.3.1 Fan mode

Press the MENU button to enter the system menu, rotate the INT control knob to select Fan Mode, and press the INT knob again to enter Fan Mode. rotate the INT control knob to select between Force and Auto, and press the INT control knob to confirm your selection.

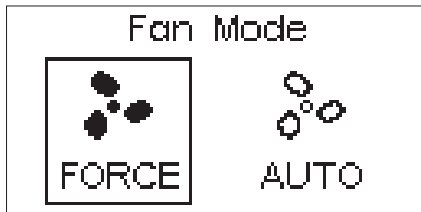



### 2.3.2 Dimming curve mode

Press the MENU button to enter the system menu, rotate the INT control knob to select Dimming Curve, and press the INT knob again to enter the dimming curve. rotate the INT control knob to choose from exponential (Exp), logarithmic (Log), S-Curve, or linear dimming curves, and press the INT control knob to make your choice.

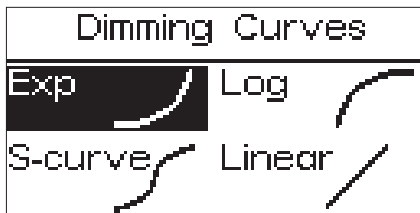

### 2.3.3 Freq. Selection

Press the MENU button to enter the system menu, rotate the INT control knob to select Freq. Selection, and press the INT knob again to enter the Freq. Selection, rotate the INT control knob to get frequency between 1 to 10. and press the INT control knob to return the previous menu.

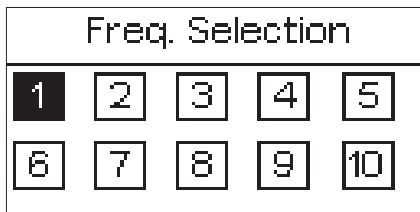

### 2.3.4 Bluetooth Reset

Press the MENU button to enter the system menu, rotate the INT control knob to select BT Reset. Press the INT control knob again to enter the BT Reset. Use the knob to select "YES" to reset the Bluetooth pairing; If you choose "NO", then it will return to the previous menu.

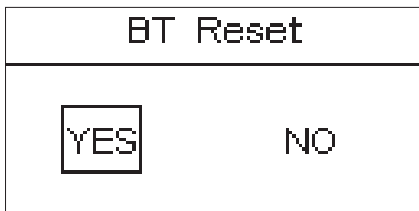

### 2.3.5 Fixture Serial No.

Press the MENU button to enter the system menu, rotate the INT control knob to select "Fixture Serial No." and you can see that device has a unique serial number.



### 2.3.6 Update Firmware

Press the MENU button to enter the system menu, rotate the INT control knob to select Update Firmware. Press the INT control knob again to enter the Update Firmware. rotate the INT control knob to select "YES" or "NO". If a USB flash drive containing a firmware update is mounted in the USB port, the screen will display an update progress bar; if you choose "NO", then it will return the menu interface.

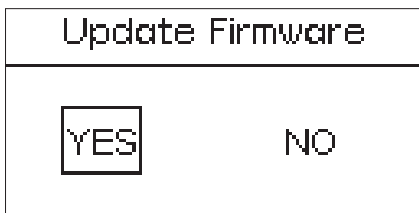

### 2.3.7 Language

Press the MENU button to enter the system menu, rotate the INT control knob to select Language, and press the INT control knob again to enter the Language interface. rotate the INT control knob to select from the available languages. Initial languages include "English" and "Chinese".



### 2.3.8 Firmware Version

Press the MENU button to enter the system menu, rotate the INT control knob to select Firmware Version, and press the INT control knob again to enter the Firmware Version interface. Then Lamp Version number and Lamp Version will appear.

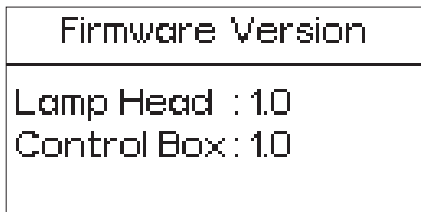

## 2.4 Fixture Presets

There are 4 preset buttons located on the bottom row of the control box. Once you have set your light to the desired output, long press and hold one of the four buttons (1, 2, 3, or 4) to start the Save Preset procedure. Use the INT control wheel to select "YES" or "NO".

You can then use those preset buttons in any Lighting Mode and it will activate the mode and settings you previously saved to that preset.

You can save a nearly infinite number of presets using the Sidus Link mobile app.

### 3. Connecting to DMX

1) Connect a standard DMX controller

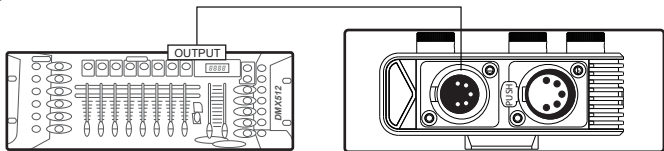

DMX512

▲  
Connecting DMX to only one NOVA P300c

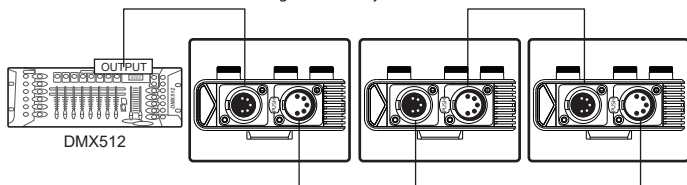

DMX512

▲  
Daisy chaining multiple lights using DMX

\* The DMX interface schematic is shown in the pictures below:

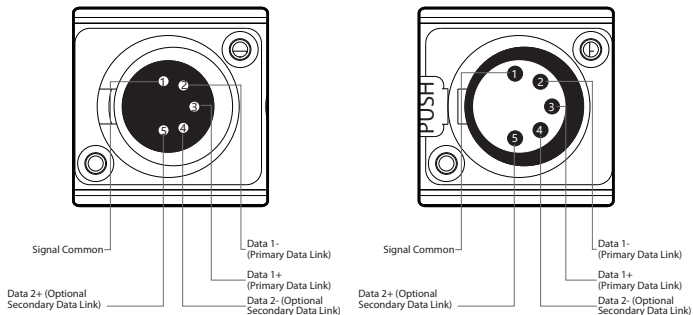

## 2) Channel Selection

In DMX mode, match the channel of your DMX controller with the light, and then adjust accordingly.

\* The default DMX channel is "001".

\*\* The range of DMX channels is 1 to 512.

## 4. Controlling Device Via DMX

1) Connect the DMX controller's OUTPUT to the Nova P300c controller's DMX INPUT as shown in the figure below.

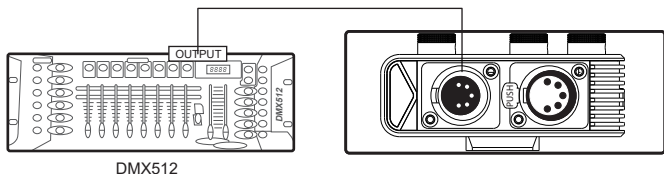

## 2) DMX Chart

Model	Channel	Function
DMX Profile1: CCT&RGB	1	INT: 0-100%
	2	Color Temp: 2000K-10000K
	3	G/M: -1.0~+1.0
	4	CCT/RGB
	5	R:INT 0-100%
	6	G:INT 0-100%
	7	B:INT 0-100%
DMX Profile 2: CCT	1	INT: 0-100%
	2	Color Temp: 2000K-10000K
	3	G/M: -1.0~+1.0
DMX Profile3: CCT&HSI	1	INT: 0-100%
	2	Color Temp: 2000K-10000K
	3	G/M: -1.0~+1.0
	4	CCT/HSI
	5	HUE: 1°~360°
	6	SAT: 0-100%
DMX Profile4: GEL	1	INT: 0-100%
	2	Color Temp: 3200K/5600K
	3	GEL Selection: R/L
	4	GEL Selection: Series
	5	GEL Selection: Model
DMX Profile5: HSI	1	INT: 0-100%
	2	HUE: 1°-360°
	3	SAT: 0-100%
DMX Profile6: Source	1	INT: 0-100%
	2	Source(contain 46 sources)
DMX Profile7: RGB	1	R INT: 0-100%
	2	G INT: 0-100%
	3	B INT: 0-100%

DMX Profile8: X,Y	1	INT: 0-100%	
	2	X-coordinate: 0.0000-0.8000	
	3	Y-coordinate: 0.0000-0.8000	
DMX Profile9: FX	1	FX Selection: Club Lights, Paparazzi, Lightning, TV, Candle, Fire, Strobe, Explosion, Fault Bulb, Pulsing, Welding, Cop Car, Color Chase, Party Lights, Fireworks	
	2	INT: 0-100%	
	3	Club Lights	Colors: 3、 6、 9、 12、 15、 18、 24、 36
	4		SPD: 1-10
	5		Stop/Loop
	3	Paparazzi	CCT: 2000-10000K
	4		G/M: -1.0~+1.0
	5		FRQ: 1-10
	6		Stop/Loop
	3	Lightning	CCT: 2000-10000K
	4		G/M: -1.0~+1.0
	5		FRQ: 1-10-R
	6		SPD: 1-10-R
	7	Stop/Loop	
	3	TV	CCT: Warmer/Natural/Cooler
	4		SPD: 1-10-R
	5		Stop/Loop
	3	Candle	CCT: Warmer/Natural/Cooler
	4		SPD: 1-10
	5		Stop/Loop
	3	Fire	CCT: Warmer/Natural/Cooler
	4		SPD: 1-10
	5		Stop/Loop

DMX Profile9: FX	3	Strobe	CCT	HSI	GEL	X, Y	SOURCE	
	4		CCT: 2000-10000K	HUE: 1°-360°	CCT: 3200K/5600K	X-coordinate: 0.0000-0.8000	Source matching	
	5		G/M: -1.0~+1.0	SAT: 0-100%	GEL Selection: R/L	Y-coordinate: 0.0000-0.8000	SPD: 1-10-R	
	6		SPD: 1-10-R	SPD: 1-10-R	GEL Selection: series	SPD: 1-10-R	Stop/Loop	
	7		Stop/Loop	Stop/Loop	GEL Selection: Model	Stop/Loop	/	
	8		/	/	SPD: 1-10-R	/	/	
	9		/	/	Stop/Loop	/	/	
	3		Explosion	CCT	HSI	GEL	X, Y	SOURCE
	4			CCT: 2000-10000K	HUE: 1°-360°	CCT: 3200K/5600K	X-coordinate: 0.0000-0.8000	Source matching
	5	G/M: -1.0~+1.0		SAT: 0-100%	GEL Selection: R/L	Y-coordinate: 0.0000-0.8000	Decay: 1-10	
	6	Decay: 1-10		Decay: 1-10	GEL Selection: series	Decay: 1-10	Stop/Loop	
	7	Stop/Loop		Stop/Loop	GEL Selection: Model	Stop/Loop	/	
	8	/		/	Decay: 1-10	/	/	
	9	/		/	Stop/Loop	/	/	
	3	Fault Bulb		CCT	HSI	GEL	X, Y	SOURCE
	4			CCT: 2000-10000K	HUE: 1°-360°	CCT: 3200K/5600K	X-coordinate: 0.0000-0.8000	Source matching
	5		G/M: -1.0~+1.0	SAT: 0-100%	GEL Selection: R/L	Y-coordinate: 0.0000-0.8000	FRQ: 1-10-R	
	6		FRQ: 1-10-R	FRQ: 1-10-R	GEL Selection: series	FRQ: 1-10-R	SPD: 1-10	
	7		SPD: 1-10	SPD: 1-10	GEL Selection: Model	SPD: 1-10	Stop/Loop	
	8		Stop/Loop	Stop/Loop	FRQ: 1-10-R	Stop/Loop	/	
	9		/	/	SPD: 1-10	/	/	
	10		/	/	Stop/Loop	/	/	



DMX Profile9: FX	3	Pulsing	CCT	HSI	GEL	X, Y	SOURCE	
	4		CCT: 2000-10000K	HUE: 1°-360°	CCT: 3200K/5600K	X-coordinate: 0.0000-0.8000	Source matching	
	5		G/M: -1.0~+1.0	SAT: 0-100%	GEL Selection: R/L	Y-coordinate: 0.0000-0.8000	SPD: 1-10-R	
	6		FRQ: 1-10-R	FRQ: 1-10-R	GEL Selection: series	FRQ: 1-10-R	FRQ: 1-10-R	
	7		SPD: 1-10-R	SPD: 1-10-R	GEL Selection: Model	SPD: 1-10-R	Stop/Loop	
	8		Stop/Loop	Stop/Loop	FRQ: 1-10-R	Stop/Loop	/	
	9		/	/	SPD: 1-10-R	/	/	
	10		/	/	Stop/Loop	/	/	
	3		Welding	CCT	HSI	GEL	X, Y	SOURCE
	4			CCT: 2000-10000K	HUE: 1°-360°	CCT: 3200K/5600K	X-coordinate: 0.0000-0.8000	Source matching
	5	G/M: -1.0~+1.0		SAT: 0-100%	GEL Selection: R/L	Y-coordinate: 0.0000-0.8000	FRQ: 1-10	
	6	FRQ: 1-10		FRQ: 1-10	GEL Selection: series	FRQ: 1-10	Min: 0-100%	
	7	Min: 0-100%		Min: 0-100%	GEL Selection: Model	Min: 0-100%	Stop/Loop	
	8	Stop/Loop		Stop/Loop	FRQ: 1-10	Stop/Loop	/	
	9	/		/	Min: 0-100%	/	/	
	10	/		/	Stop/Loop	/	/	
	3	Cop Car		Colors: R/B/R+B/B+W/R+B+W				
	4			FRQ: 1-10				
	5		Stop/Loop					
	3	Color Chase	SAT: 0-100%					
	4		SPD: 1-10					
	5		Stop/Loop					

DMX Profile9: FX	3	Party Lights	SAT: 0-100%
	4		SPD: 1-10
	5		Stop/Loop
	3	Fireworks	CCT+HUE: CCT/HUE/CCT+HUE
	4		FRQ: 1-10-R
	5		Stop/Loop

*\* You can get more detail information about DMX by visiting [http://aputure.com/wp-content/uploads/2020/03/dmx\\_chart\\_of\\_aputure\\_nova\\_p300c.pdf](http://aputure.com/wp-content/uploads/2020/03/dmx_chart_of_aputure_nova_p300c.pdf)*

## 5. Using the Sidus Link APP

You can download the Sidus Link app from the iOS App Store or Google Play Store for enhancing the functionality of the light. Please visit [sidus.link/app/help](https://sidus.link/app/help) for more details regarding how to use the app to control your Aputure lights.



[Sidus.link/app/help](https://sidus.link/app/help)



Get Sidus Link™ App

## Specifications

Operating Temperature		-10~45°C
Power Supply		AC 100~240V 50/60Hz
Operating Current		4A
Power Input		≤360W
Power Output		≤300W
CRI		≥95
TLCI		≥95
CCT		2000K-10000K
CQS		95
SST(D55)		74
SST(Tungsten)		85
App Control Type		Bluetooth 5.0 Mesh
Battery Operating Voltage Range		24V-48V
Cooling Mode		Active Cooling
Fixture Net Weight		12.6kg
Sizes (L*W*H)	Light	56.19*45.7*17.2cm / 22.1*18.0*6.77in
	Controller box	9.66*15.75*4.63cm / 3.8*6.2*1.82in

## Photometrics

CCT	1m	3m	5m
2700K	7450 lux	890 lux	350 lux
3200K	8200 lux	960 lux	370 lux
4300K	8600 lux	1000 lux	395 lux
5500K	9000 lux	1100 lux	430 lux
6500K	8550 lux	1020 lux	400 lux

*\* This data is based on average brightness measurements, there will be slight variations between lights.*

# Aputure®

## GUARANTEE CARD

## Service Warranty (EN)

Aputure Imaging Industries Co., Ltd. warrants the original consumer purchaser from defects in material and workmanship for a period of one (1) year after the date of purchase. For more details of warranty visit [www.aputure.com](http://www.aputure.com)

### Important:

Keep your original sales receipt. Be sure the dealer has written on it the date, serial No. of the product. This information is required for warranty service.

### This warranty does not cover:

- Damage that is the result of misuse, abuse, accident (including but not limited to damage by water), faulty connection, defective or maladjusted associated equipment, or the use of the product with equipment for which it was not intended.
- Cosmetic defects that appear more than thirty (30) days after the date of purchase. Cosmetic damage caused by improper handling is also excluded.
- Damage that occurs while the product is being shipped to whoever will service it.

### This warranty is void if:

- The product identification or serial No. label is removed or defaced in any way.
- The product is serviced or repaired by any one other than Aputure or an authorized Aputure dealer or service agency.

Aputure Imaging Industries Co., Ltd.

Add: F/3, Building 21, Longjun Industrial estate,

HePing West Road, Shenzhen, Guangdong

E-MAIL: [cs@aputure.com](mailto:cs@aputure.com)

Sales Contact: (86)0755-83285569-613

Serial No.	
Item Name	
Purchase Date	
Buyer Name	
Buyer Phone	
Buyer Add	
Franchiser Seal	

# Aputure®

Aputure Imaging Industries Co., Ltd.

Inspection: Qualified

Add: F/3, Building 21, Longjun Industrial Estate, HePing West Road, Shenzhen, Guangdong